

INSTALLATION INSTRUCTIONS

1413/428/00
ISSUE 01

LEVER OR KNOB OPERATED OUTSIDE ACCESS DEVICE (OAD) FOR PANIC & EMERGENCY EXIT DEVICES

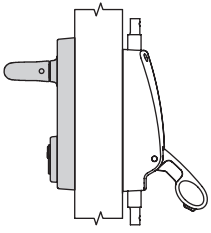

THIS DEVICE IS AVAILABLE IN LEVER AND KNOB VARIATIONS AND PERMITS FREE ACCESS FROM OUTSIDE WHEN UNLOCKED BY KEY HOLDER. WHEN LOCKED, IT WILL PERMIT IMMEDIATE EXIT FROM INSIDE VIA PANIC OR EMERGENCY EXIT DEVICE.

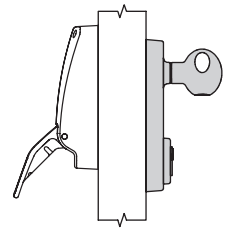

THESE INSTRUCTIONS ARE SUPPLEMENTARY AND SHOULD BE READ IN CONJUNCTION WITH THOSE PROVIDED WITH PANIC OR EMERGENCY EXIT DEVICE.

KNOB OPERATED DEVICE

The knob operated device is supplied fully assembled to suit both LH and RH Doors.

LEVER OPERATED DEVICE

The Lever Handle of this device is supplied separately and must be assembled as follows to suit either RH or LH doors.

- 1) Place Bearing Washer over corresponding Shaft diameter.
- 2) Assemble Lever to Shaft to suit hand of door required.
- 3) Secure Lever to Shaft with the Shear Screw using Allen Key Supplied.

NOTE: Shear Screw must be fully tightened to allow Screw to shear at correct level of force if device is abused in operation.

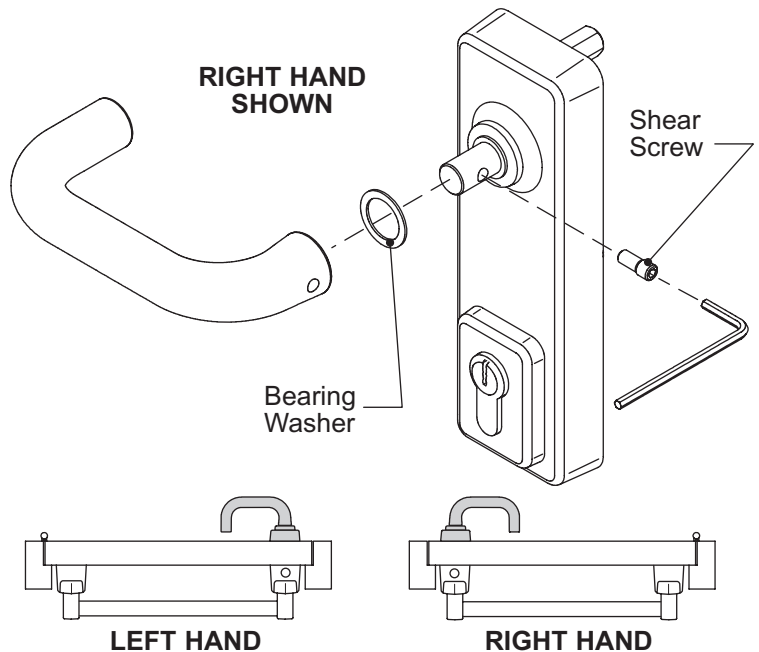

MECHANISM HANDING (LEVER AND KNOB)

The device is supplied to function with all RH devices as shown in table but can be reversed to function with a LH Device if required.

RH (Right Hand) OAD Device to suit	LH (Left Hand) OAD Device to suit
RH and LH Push Bar Panic Bolt or Emergency Push Pad Bolt	
RH Push Bar Panic Latch or RH Emergency Push Pad Latch	LH Push Bar Panic Latch or LH Emergency Push Pad Latch
RH Push Bar Mortice Panic Nightlatch or RH Push Pad Mortice Emergency Nightlatch	LH Push Bar Mortice Panic Nightlatch or LH Push Pad Mortice Emergency Nightlatch

To change OAD to function with a LH device proceed as follows.

- 1) Rotate Knob/Lever fully in either direction and hold depressed.
- 2) Using Square Drive Spindle fully rotate follower in a Clockwise direction.
- 3) Release Knob/Lever and finally align Letter 'L' on follower with 'A' on Backplate.

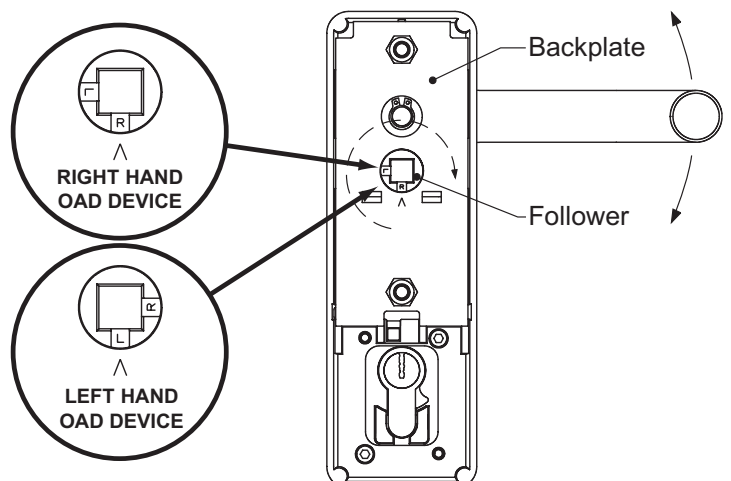

INSTALLATION

- 1) From established Push Bar/Push Pad height mark position of top edge of Operating Box on **PUSH SIDE** of the door face then remove from door.

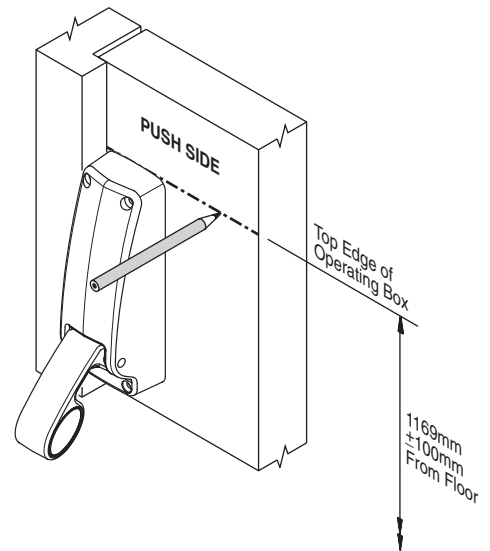

- 2) Mark **horizontal** position of Follower centre according to exit device being installed on **PUSH SIDE**.

DEVICE	A
Push Bar Panic Bolt Emergency Push Pad Bolt	46mm
Push Bar Panic Latch Emergency Push Pad Latch	76mm
Push Bar Mortice Panic Nightlatch Push Pad Mortice Emergency Nightlatch	Refer to Template supplied with device

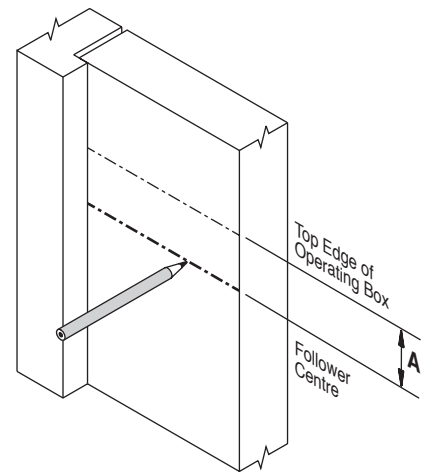

- 3) i) Mark **vertical** position of Follower centre on **PUSH SIDE** according to type of door the exit device is being installed on.

- ii) Drill hole $\text{Ø}20\text{mm}$ through from established Follower centre position.

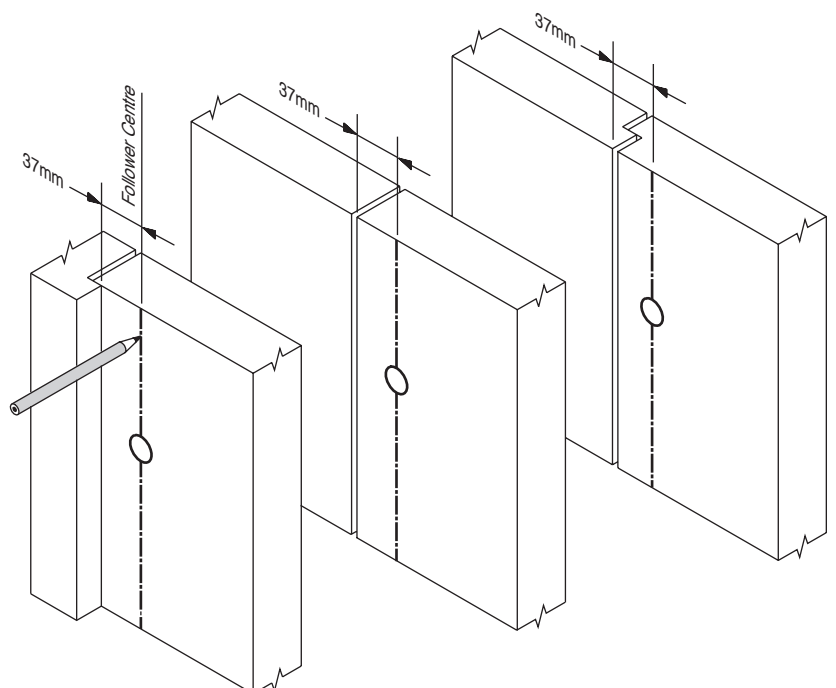

- 4) Using the Fixing Template on the **PULL SIDE** of door, align with Follower hole making sure it is parallel to edge of door or frame and mark positions for Fixing Stud centres and Cylinder relief.

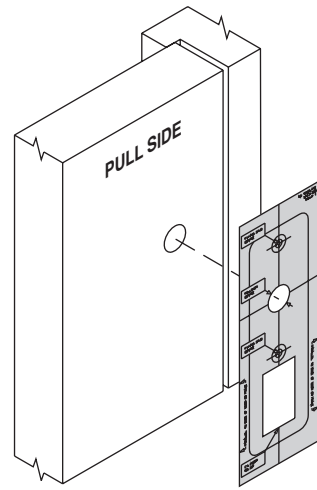

- 5) Prepare door as shown below:

- i) Drill Fixing Stud centres $\text{Ø}6\text{mm}$ through from **PULL SIDE**.
- ii) Counterbore Fixing Stud centre $\text{Ø}13\text{mm}$ x 28mm deep from **PULL SIDE**.
- iii) Prepare Cylinder relief 20mm deep from **PULL SIDE**.
- iv) Countersink Fixing Stud centres $\text{Ø}10\text{mm}$ from **PUSH SIDE**.

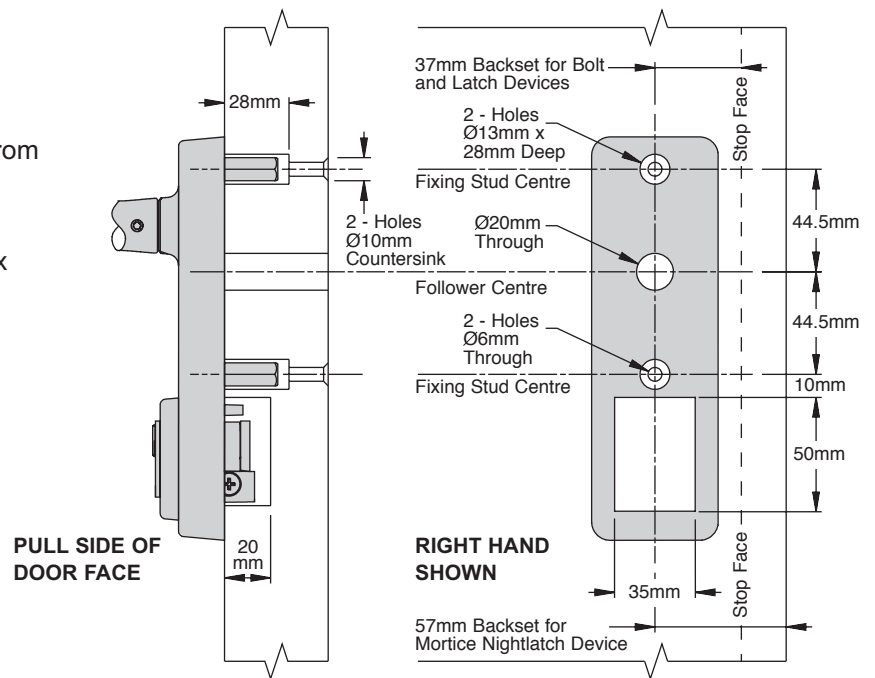

- 6) Fit OAD to door using relevant screw length provided.

Door Thickness	Screw Length
40mm - 55mm	M5 x 40mm Long
56mm - 70mm	M5 x 60mm Long

- 7) Insert Square Drive Spindle through door and fully into OAD Follower. Mark **9mm** projection from door face and cut to length.
NOTE: When installing OAD with Mortice Nightlatch Device, Square Drive Spindle should pass through Follower in Mortice Nightlatch.

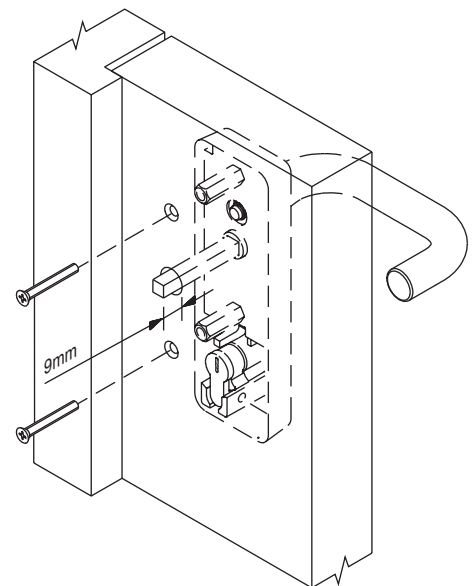

- 8) Continue with installation of Exit Device to instructions provided.

- i) Ensure when door is closed that OAD can be Locked and Unlocked using Key provided and then opened freely.
- ii) Ensure when door is closed and locked that the Exit Device operates freely and permits **immediate exit**.

OPERATION

To lock the device to prevent access from the outside turn the Key in the Cylinder in a clockwise direction. This will prevent the Knob/Lever from rotating, but immediate exit can still be gained from inside.

To unlock the device and gain access from the outside turn the Key in an anti-clockwise direction, and then turn the Knob/Lever to withdraw Bolts or Latch.

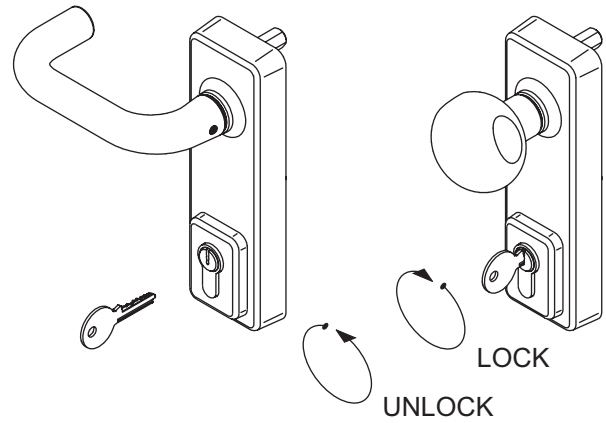

REPLACING SHEAR SCREW

This device has a Shear Screw incorporated into the Lever/Knob that will fail if an attempt is made to gain unauthorised entry through excessive means when the device is Locked. The Screw will shear at a torque value of between 40-50Nm.

Replacement Shear Screws are available upon request to the manufacturer.

To replace the Shear Screw, ensure that the Lever/Knob is in it's original position and remove the head of the Screw using an Allen Key.

Once the Lever has been taken off, remove the stem of the Shear Screw from the Shaft.

Re-assemble the Lever/Knob to the Shaft ensuring that the Bearing Washer is in place.

Finally secure the Lever/Knob to the Shaft with the new Shear Screw using an Allen Key.

NOTE: Shear Screw must be fully tightened to allow Screw to shear at correct level of force if device is abused in operation.

